

# MEDICIONES ELÉCTRICAS

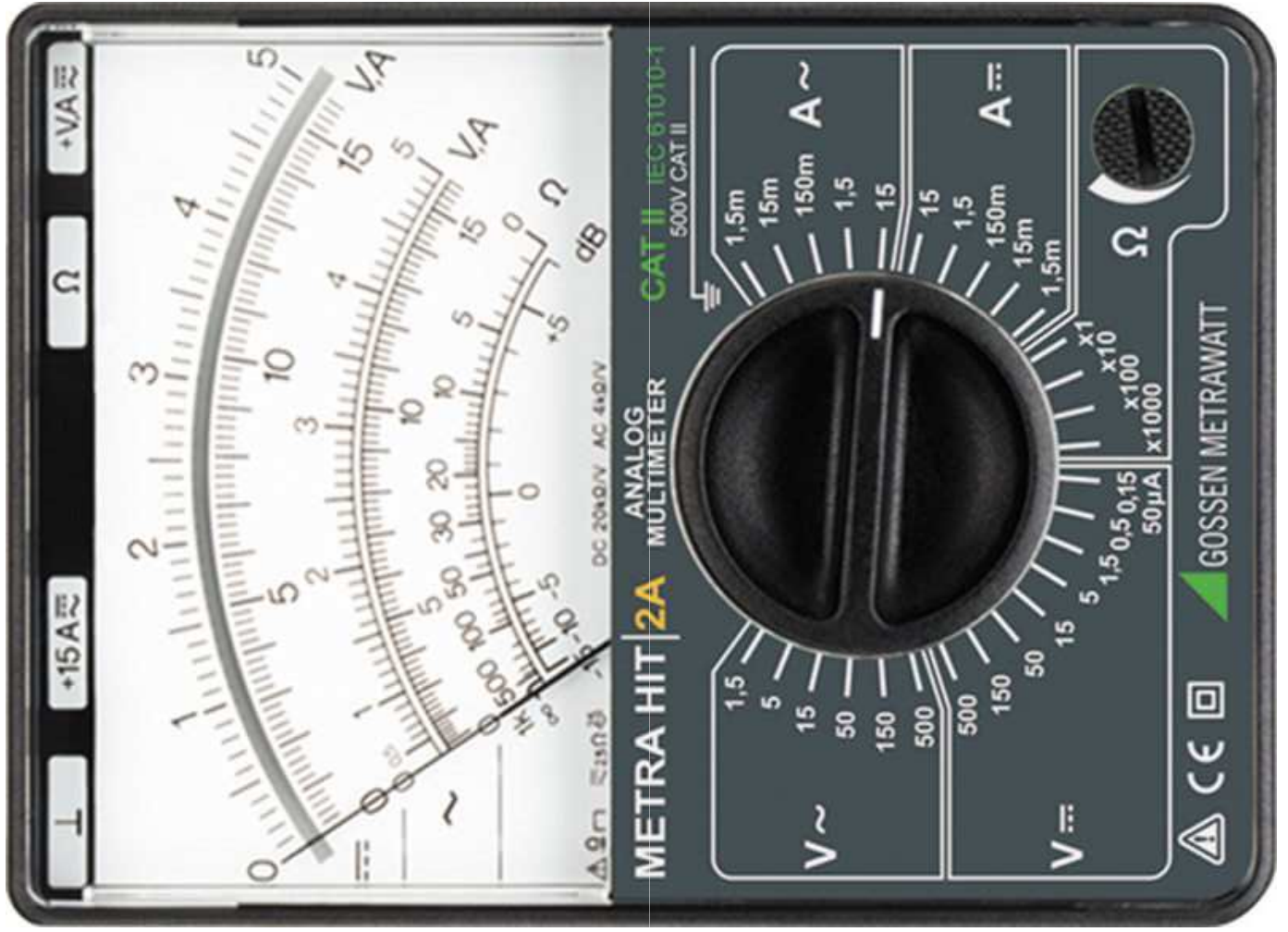

Color	1Ra.Banda	2Da.Banda	3Ra.Banda	Multiplicadora	Tolerancia
negro	0	0	x1		
café	1	1	x10		
rojo	2	2	x100	2%	
naranja	3	3	x1000		
amarillo	4	4	x10000		
verde	5	5	x100000		
azul	6	6	x1000000		
violeta	7	7	x10000000		
gris	8	8	x100000000		
blanco	9	9	x1000000000		
				dorado	5%
				plata	10%



I

+15A

Ω

+VA



ANALOG MULTIMETER

METRA HIT 2A ANALOG MULTIMETER CAT II IEC 61010-1 500V CAT II



V~

A~

V⋯

A⋯

Ω



CE

GOSSEN METRAWATT

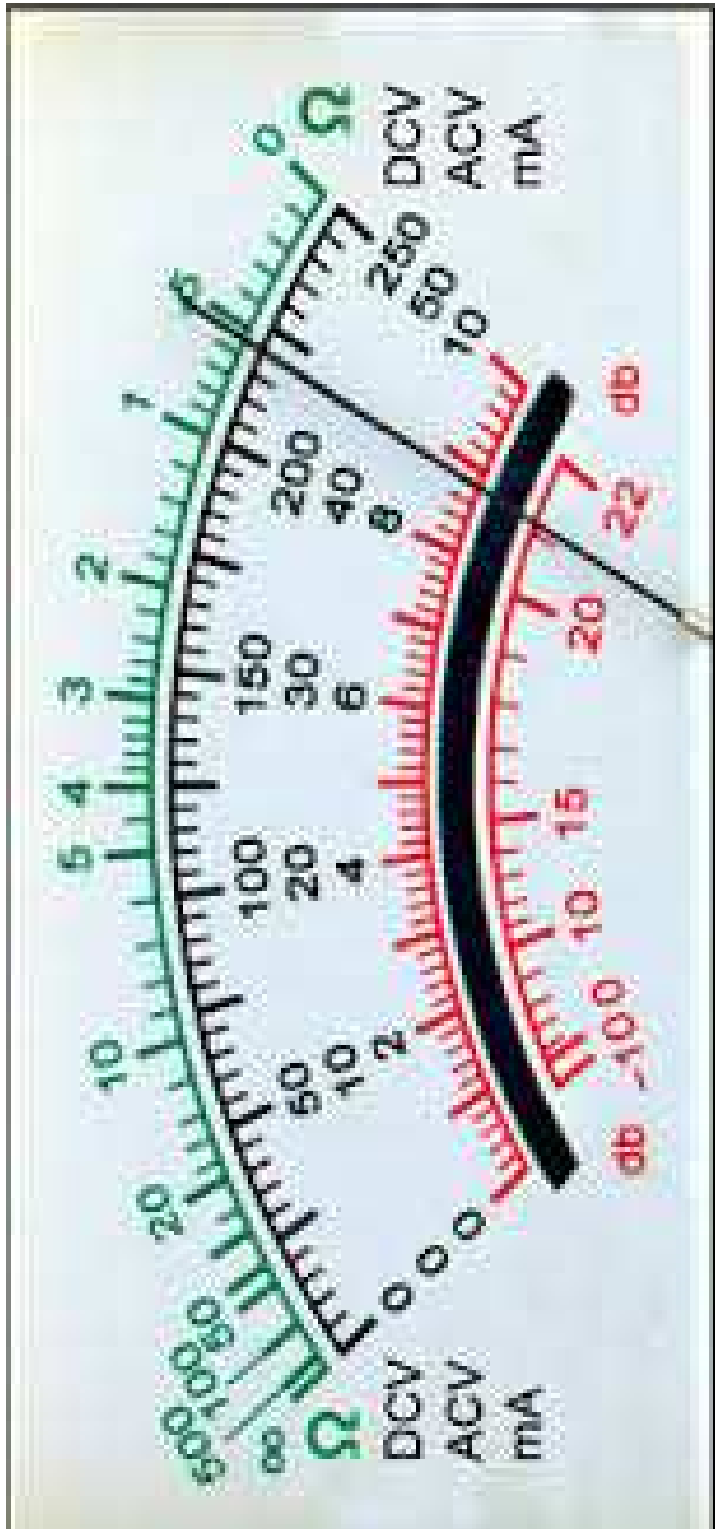





# Circuito Serie y Paralelo

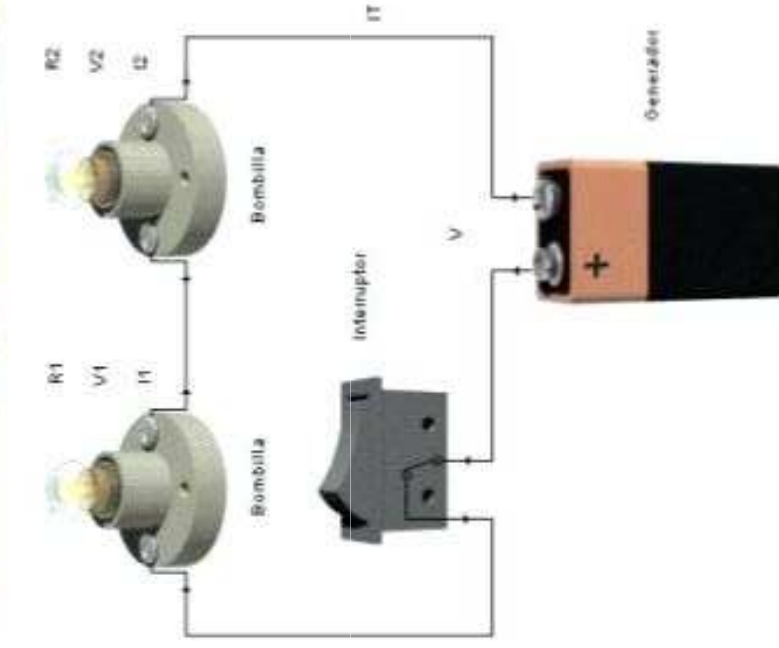

**Circuito serie**

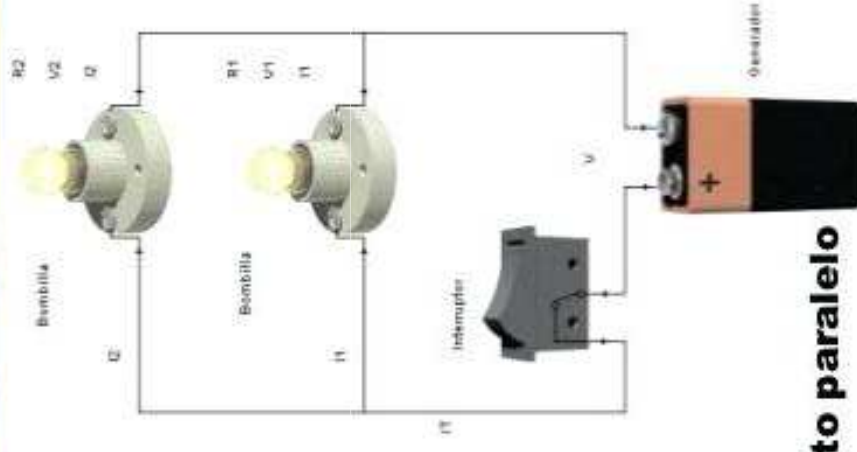

**Circuito paralelo**



## MEDICIÓN DE CORRIENTE : MEDIR EN SERIE

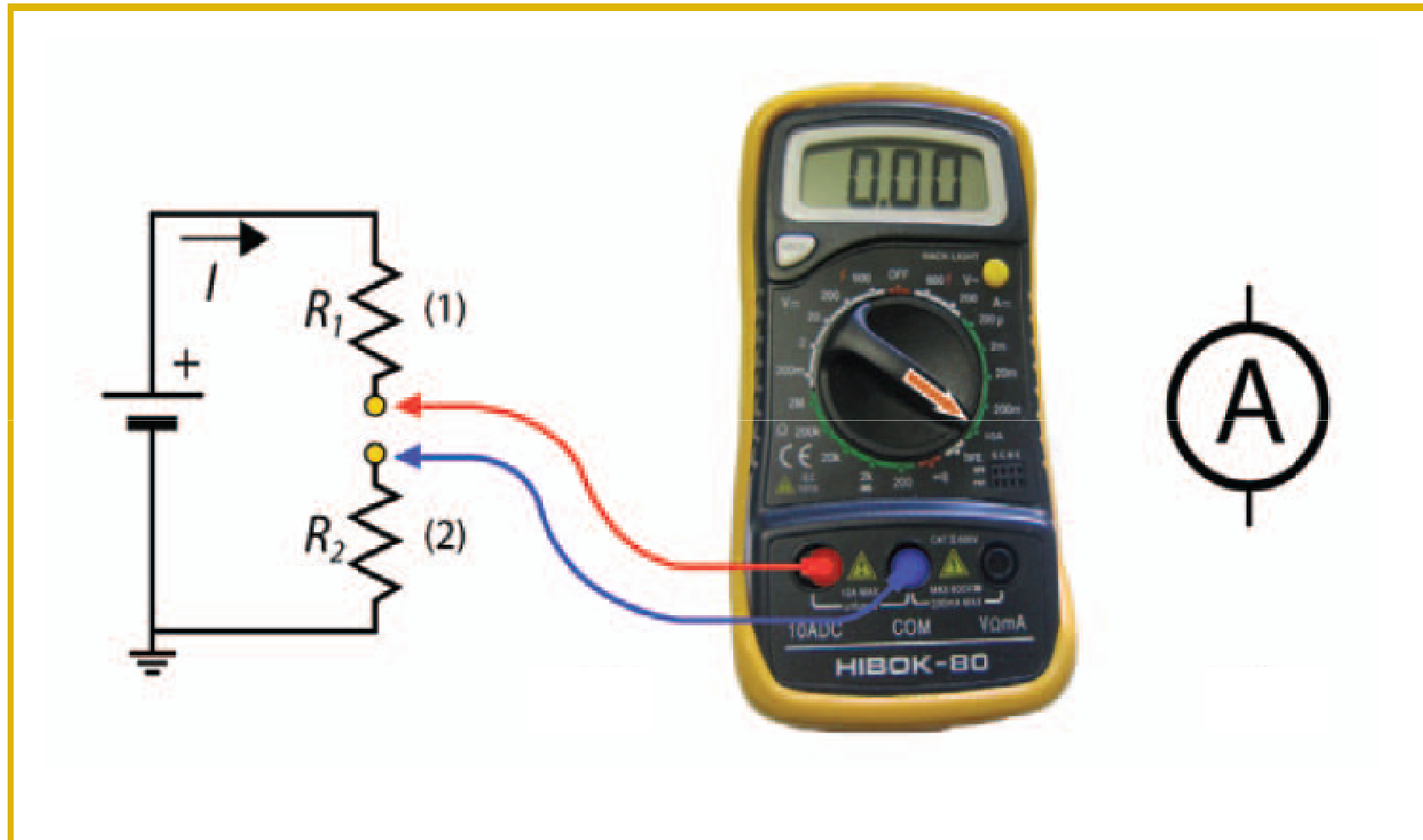

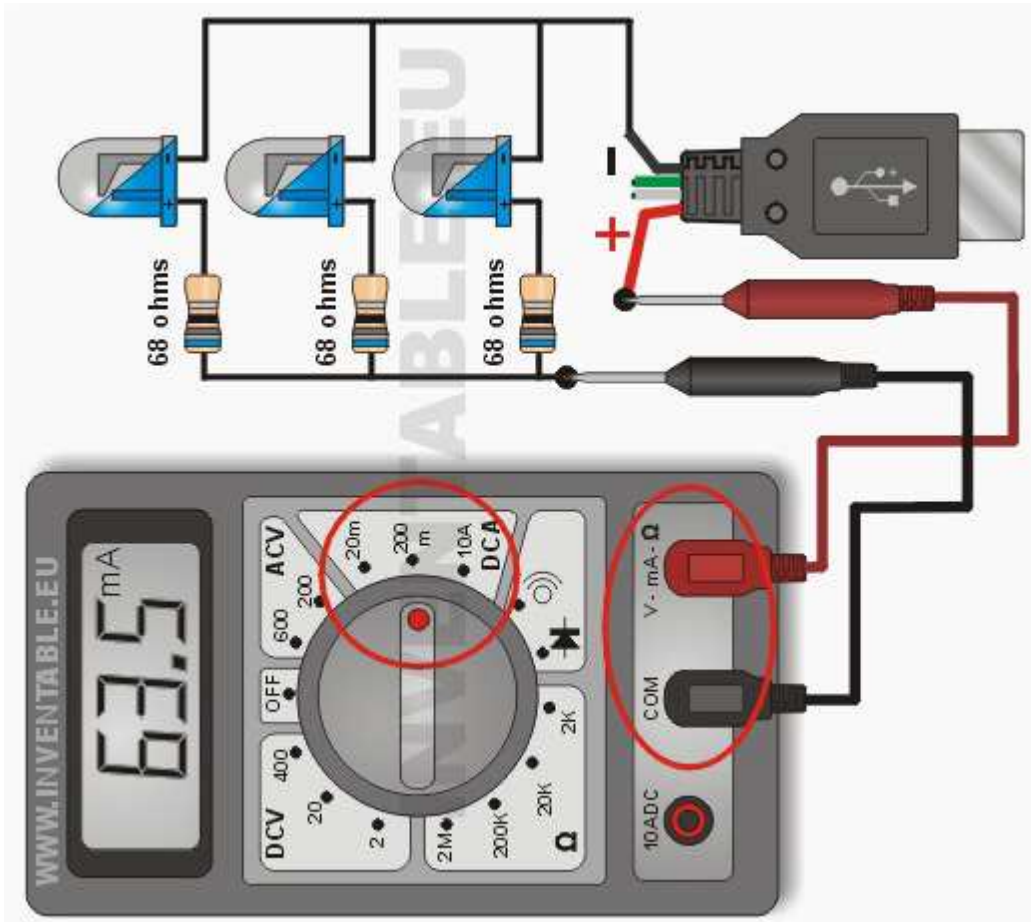

## MEDICIÓN DE VOLTAJE : MEDIR EN PARALELO

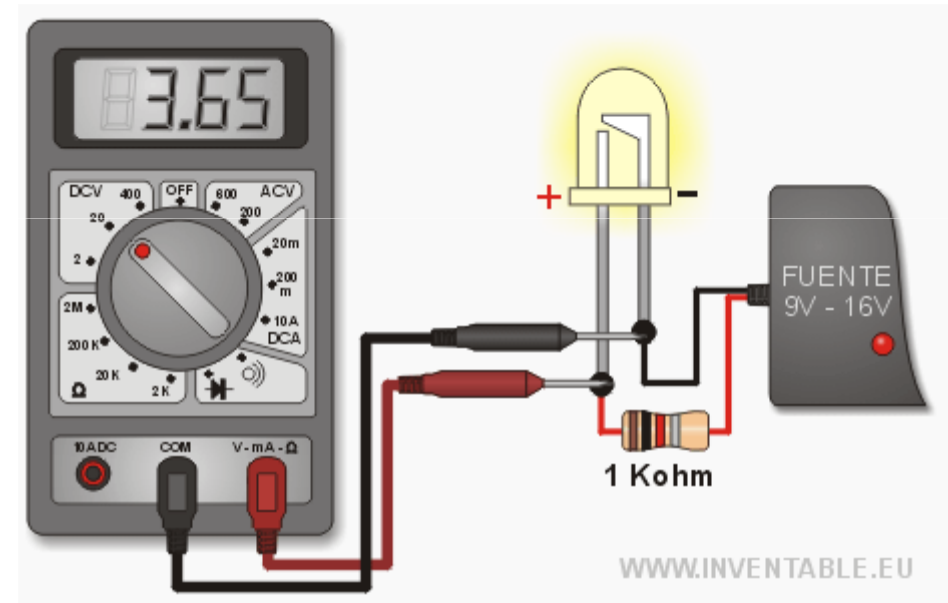
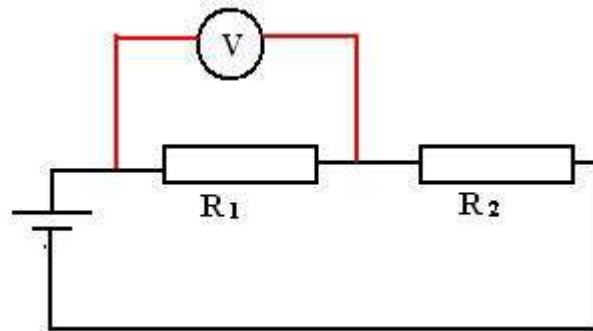

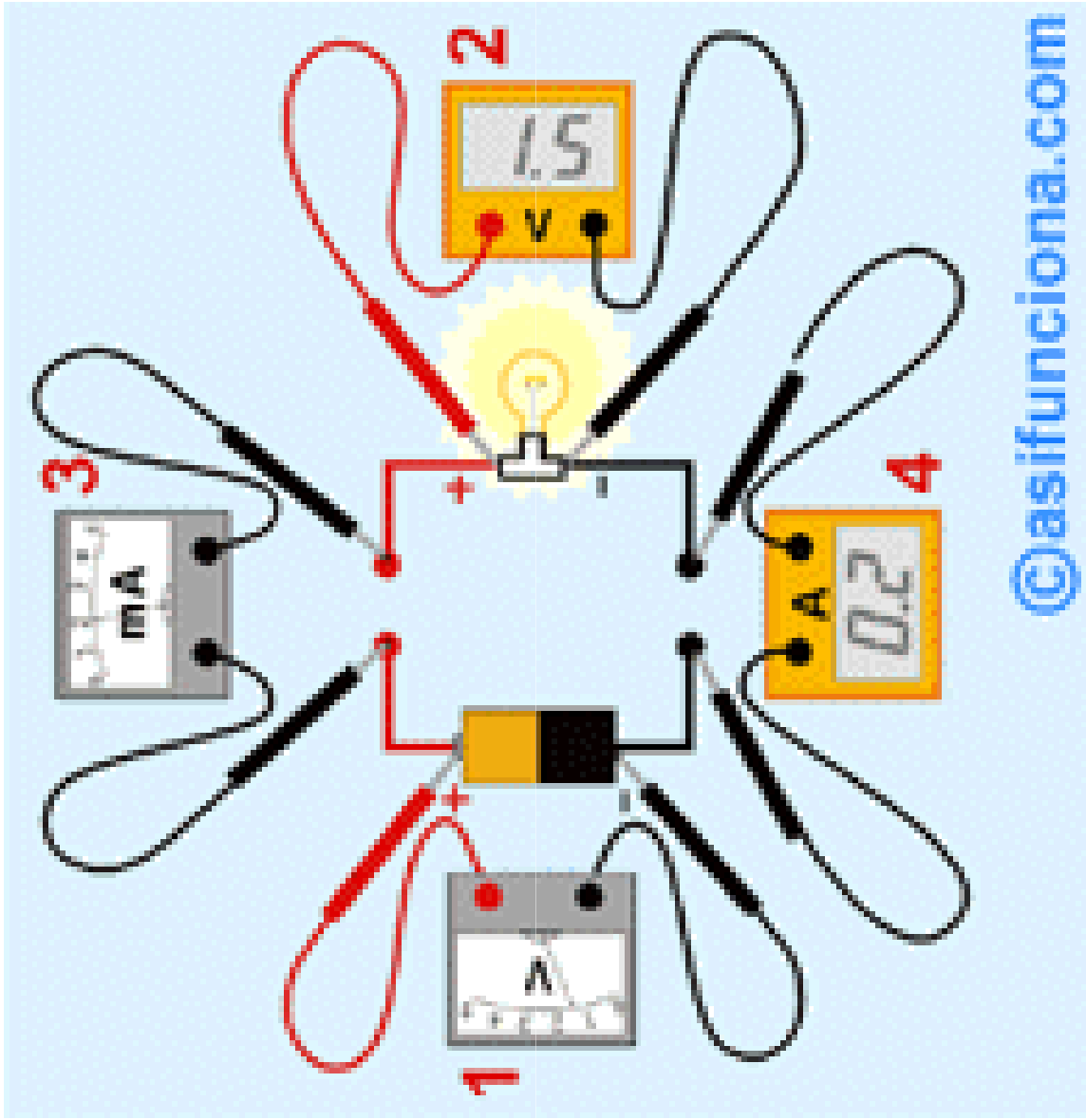

©asifunciona.com